

**RINGSPANN®**

2024

Press folder

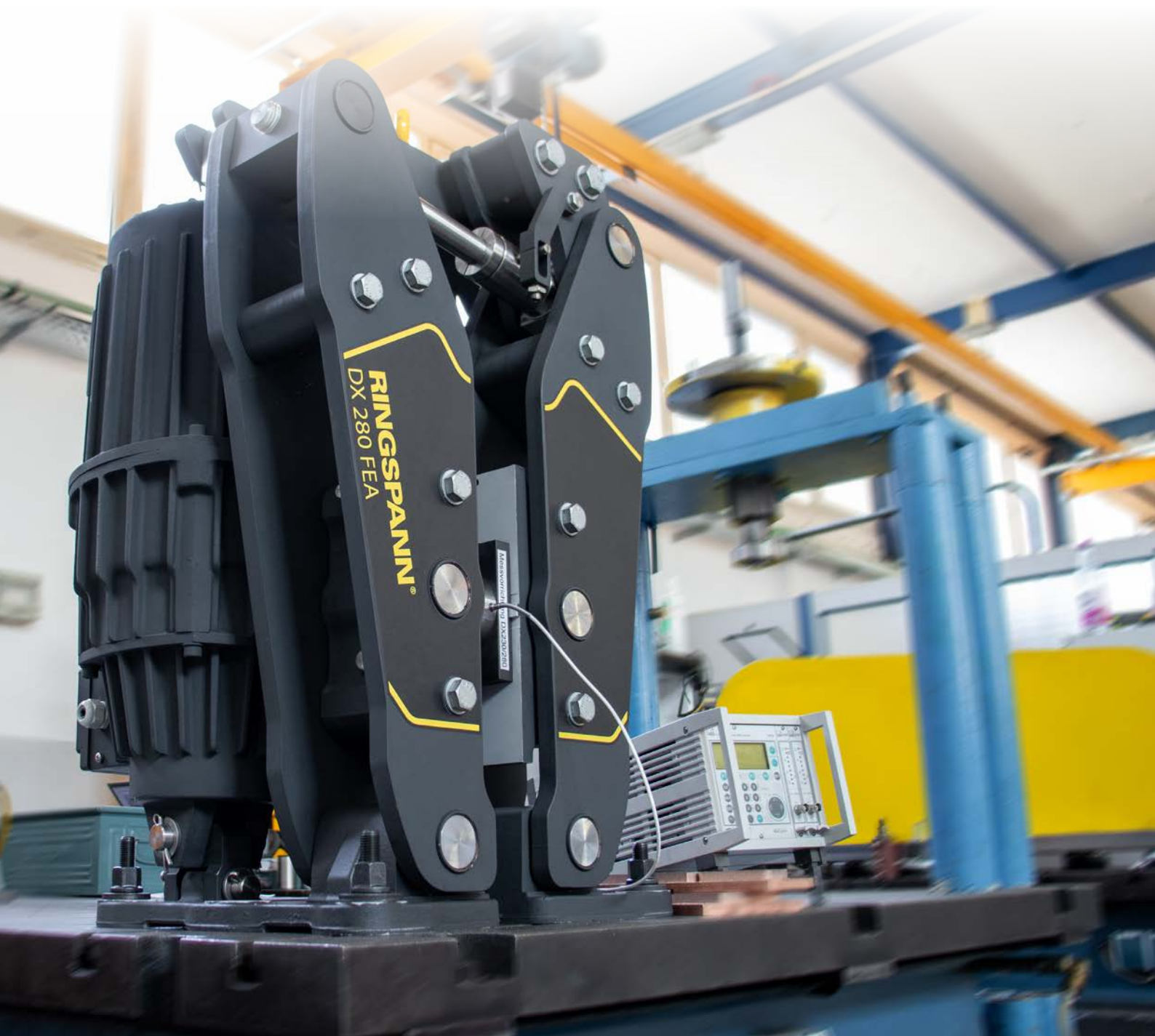



## Extremely fast and without damaging flank changes

**The provision of state-of-the-art braking and emergency stop systems for the drive units of industrial and harbour cranes has been part of RINGSPANN's range of services for many years. Now, however, the company's brake technology specialists are presenting two innovations that offer crane builders and hoist designers completely new perspectives. These are new developments that are readily available and are also suitable for easy retrofitting of existing electrohydraulic disc and drum brakes. As a duo, they pave the way for the realisation of highly dynamic, safe and low-maintenance heavy-duty hoists.**

"Our two new developments in the field of brake technology have what it takes to revolutionise the design of heavy-duty hoists for use in industrial and harbour cranes," says Martin Ohler, Business Developer Brakes at RINGSPANN. He leaves no doubt about the importance of his division's latest innovations. And if you look closely, it actually turns out that he could be right. Because what the brake technology specialists of the German company have come up with this time starts exactly where many hoist designers have problems: coping with the enormously high dynamic forces to which the trend towards ever faster and more efficient drive systems forces them. At the same time, the innovations are astonishing due to their simplicity, which is shown by the fact that their use does not require a complete replacement of existing disc or drum brakes from RINGSPANN. "From the very beginning, our aim was to provide retrofittable solutions for the safe control of the ever-increasing energy pulses in crane construction, which score points with high availability and MRO affinity and also improve the performance of the hoists," emphasises Martin Ohler. He and his

team have achieved these goals through two crucial new developments: First, a thruster that gives the electrohydraulic brakes of the DX, DS and DT series from RINGSPANN mounted on the motor side of the hoists exceptionally short closing times. And secondly, a control unit that significantly increases the service life of the hoist gearboxes.

### "Less than 0.08 seconds closing time"

The extremely short, above-average fast and flexibly adjustable closing times of the new thruster are the result of a benchmark in which the RINGSPANN engineers compared the effects of different pump types on the closing process of the hoist brakes used on the motor side. This showed that the use of a special gear pump could significantly reduce the volume of oil that has to be displaced during closing. "This gives the brake a dynamic that was previously hard to imagine. We were able to measure closing times of less than 0.08 seconds," reports Martin Ohler. In addition to the fact

that the low oil consumption, and the fact that the brake switches to a low-power depressurised mode after opening together reduce the operating costs of the hoist – and minimise its ecological footprint – the responsiveness and flexibility of the brake result in far-reaching functional, safety and maintenance advantages for the drive unit.

## No flank change, no pitting

In particular, one aspect should be mentioned here that has repeatedly caused major problems for hoist designers to date: since the new thruster from RINGSPANN offers the possibility of varying the closing times, it can be used to eliminate tooth flank changes in the hoist gearbox. Martin Ohler explains: "Tooth flank changes always occur when braking is first on the 'wrong' side. When lifting, the braking effect must first set in on the transmission side, as the driving force is the engine. In lowering, on the other hand, the driving force is the crane hook with the load. Since the engine only follows this force, it is necessary to brake on this side first. By varying the closing time, it can be ensured that the brakes are always applied in time on the opposite side of the driving force, so that the pairs of teeth remain in close contact at all times and cannot hit each other." Regardless of the direction of travel, the gearbox between the drive motor on the one hand and the winch on the other side is relieved in such a way that a harmful flank change of its gears is ruled out. This prevents the formation of cracks and pitting on the contact surfaces of the gear pairs, reduces downtime due to repairs and gives the gearbox a significantly longer service life. Other positive effects include reducing the operating noise of the hoist and avoiding harmful vibrations.

## Reduction of load peaks

The effect of the second brake technology innovation from RINGSPANN – a new control unit – also leads to important relief. This is because it makes it possible to pre-select the emergency holding brakes used in the hoist via several valves and thus adapt the required braking forces to the driving speed and load. The user can set two different closing times in order to optimally adjust the safety factor of the emergency stop and service brakes to the actual driving conditions. "The result is a reduction in load peaks on the entire crane structure – especially the bearings and gears," says Martin Ohler.



Both braking innovations from RINGSPANN are extremely easy to integrate for the user. Thus, the new thruster is a compact, relatively light, maintenance-friendly and purely analogue unit without electronic components (circuit boards). It can be put in place of the previous thruster in just a few simple steps and almost all further adjustment and maintenance work on it can be carried out without removing it from the brake. Another great advantage is that many brakes of different sizes can be equipped with just a few thruster versions. The resulting reduction in variants simplifies spare parts management, makes it easier for the user to acquire know-how for all MRO work and minimises the expense required for warehousing.

It's a similar story with the new control system. It consists entirely of components from the RINGSPANN one-stop shop and can be used quickly by making small modifications to the thruster. In addition, it is a hard-wired solution that meets the highest safety standards and can also be easily replaced or retrofitted. "The requirements for the customer's data interface are simple, because our new control unit only needs a single signal: is the hoist running in lowering or lifting mode?" says Martin Ohler.

## Significant added value

With its new all-in-one solution consisting of a high-speed thruster and intelligent control system, RINGSPANN offers designers of hoists and hoists for container, harbour and industrial cranes a braking innovation that enables them to create considerable added value for their customers. This is because hoists equipped with them will work more efficiently, cost-saving, resource-saving and safer than previous units. They meet the growing performance and quality requirements in modern crane construction and offer considerable competitive advantages. <<



**Martin Ohler**  
RINGSPANN-  
Business Developer  
Brakes

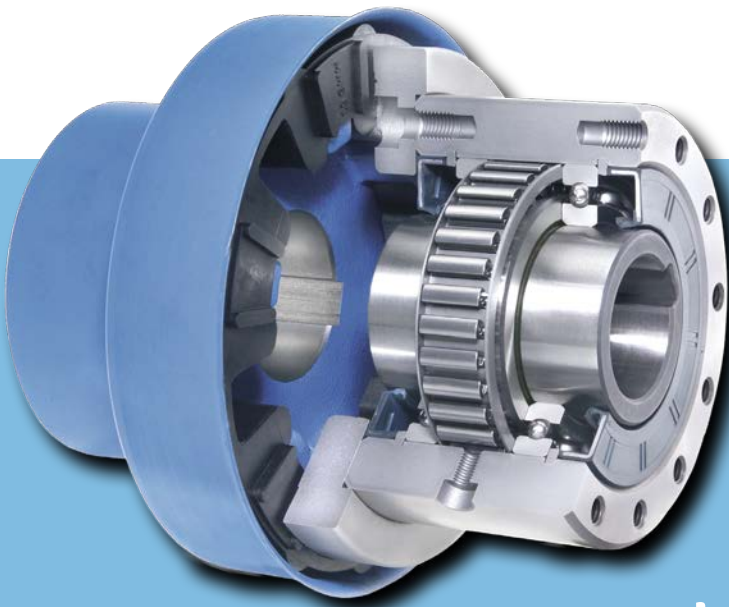

# Manoeuvring in sustainable combination operation

**Modern ships and yachts today have hybrid propulsion systems in which diesel or methanol generators and electric motors share the work. A key design function for the efficient interaction of the two units is performed by the complete and cage freewheels from the RINGSPANN portfolio. Read here which series are currently in particularly high demand in marine technology and how they enable flexible and environmentally friendly manoeuvring at sea and in port.**

„At present, it is above all demands for significantly lower nitrogen oxide emissions and higher energy efficiency that are driving the development of hybrid propulsion systems in shipbuilding and yacht construction. The designers of many system integrators, owners and shipyards are therefore pursuing the goal of creating serial or parallel hybrid propulsion systems from the combination of diesel or methanol generators and electric motors. Linked to this is also the idea that the drives are protected, always run at optimum efficiency and can be designed smaller and lighter from the outset. One of the components that plays a key kinematic role in this process is the freewheel. After all, this is what enables reliable, precise and, ultimately, easy to implement interplay in terms of design between the various power units of the hybrid system. A closer look even shows that the use of the right freewheel technology in the powertrain of diesel and electric motors allows up to three different operating modes to be implemented: in the first case, the diesel engine is the main propulsion system, but it rotates an electric motor in generator mode via a freewheel as needed to charge the ship's electrical energy storage systems and supply the on-board electrical system. This offers great advantages for long distances and constant sailing in open waters. In the second case, the electric motor supports the diesel engine via the freewheel, depending on the speed, in order to achieve more power. And in the third case, the freewheel separates the diesel engine from the drivetrain, and only the electric motor works. This is particularly useful when manoeuvring in ports, as strict environmental regulations apply here, and the diesel engine also proves to be less efficient than when sailing constantly on the open sea.

## Freewheel technology ensures efficiency and flexibility

Flexible hybrid systems, in which freewheels support all three operating modes, are used, for example, in container ships, passenger ships and car ferries. But modern sailing yachts and catamarans have also long been equipped with hybrid propulsion systems, in which freewheels enable energy-efficient and flexible operation. "Here, for example, a freewheel is placed between the diesel engine and the drive train, so that an electric motor can be operated as a generator while sailing via the ship's propeller. In this way, the on-board electrical system can be charged – without carrying the diesel engine along or even damaging it," explains Marco Sommer, freewheel designer at RINGSPANN.

RINGSPANN is the world market leader in the field of freewheel technology and equips many well-known shipbuilders and boat builders with various freewheel types from its comprehensive range. At present, it is mainly the complete

**Marco Sommer**  
Engineering Freewheels  
at RINGSPANN GmbH





freewheels of the FB and FBE series as well as the cage freewheels of the SF and SFB series that are preferred by designers of marine technology. "On special request, we have already implemented numerous special solutions for hybrid ship propulsion systems – for example, on the basis of the proven basic freewheels of our FBO series," reports Marco Sommer.

### Ready-to-install and optimised service life

The complete freewheels of the FB series are ready-to-install sprag freewheels for nominal torques of up to 160,000 Nm, which can be used for feed and overtaking functions as well as backstops. They are run on ball bearings, sealed and supplied by RINGSPANN oil-filled and ready for installation. Since they are available at the factory with many bore diameters of up to 300 mm, they are quickly available for numerous applications. In addition to the standard versions, the FB series also offers three other types for applications where a particularly long service life is required. "We maximize service life by using special sprag coatings or various types of sprag lift-off, which significantly reduce wear on the sprags," explains Marco Sommer. In the FBE variant, the complete freewheels also have a clutch, so that they can be installed in the drive train of the hybrid system without additional assembly effort.



Cage freewheels in the SF and SFB series are also sprag freewheels, but do not have their own bearings and are preferably installed between the customer's inner and outer rings. They are suitable for nominal torques of up to 93,000 Nm and are available in a standard version and two variants for applications with increased service life requirements. RINGSPANN supplies them primarily for cases in which the function of an overrunning clutch or a backstop is to be integrated directly into a gearbox. "This always occurs in the design of hybrid ship propulsion systems when the coupling of combustion engine and electric motor is resolved via a gearbox; the drives are therefore arranged in parallel and not in series. Due to the installation in the gearbox, the freewheel is also better protected from environmental influences," reports Marco Sommer.

With the high quality of its freewheels, the high availability of life-optimised, ready-to-install complete freewheels – with or without a clutch – and ultimately also with the possibility of implementing special solutions, RINGSPANN offers manufacturers of hybrid drive systems for shipbuilding and boatbuilding considerable added value. At the same time, it gives designers the freedom they need to develop innovative and sustainable concepts of propulsion technology for use in commercial, professional, sports and naval shipping.





# "Deep into all areas of mechanical engineering"



**Franz Eisele**  
Head of Division Brakes,  
Couplings, Clamping  
Fixtures and Shaft-  
Hub-Connections at  
RINGSPANN GmbH

With its current range of industrial brakes, RINGSPANN now covers all areas of application in modern mechanical and plant engineering. In particular, disc brakes of the DH, DU and DV series have established themselves as permanent fixtures here. Thanks to the company's one-stop shop philosophy, they are quickly available, can be configured for specific applications and combined with other components to create ready-to-install smart solutions. In traditional mechanical engineering, these brake callipers currently perform many different tasks.

In the recent past, RINGSPANN has significantly expanded its one-stop shop, especially in the industrial brake category. This means that designers and development engineers in the mechanical and plant engineering sector now have a

large selection of disc and drum brakes that open up a great deal of scope for the implementation of high-performance emergency stop, control, positioning and holding functions. "Across all model types, we cover braking torques from 10 to 38,500 Nm. Equally important, however, is that we can adapt each brake to the customer's needs and, if desired, combine it with other components from our one-stop shop – such as couplings, shaft-hub connections and brake discs – to create easy-to-install smart solutions," says Franz Eisele. What the head of the RINGSPANN Brakes and Couplings Division means in concrete terms can be illustrated by the many project solutions that focus on the brake callipers of the company's DH, DU and DV series.

## Smaller motors thanks to optimum brakes

When, for example, a fan manufacturer needed a universal brake that was suitable for centrifugal fans of several sizes as part of the reduction of its bought-in components, RINGSPANN was able to fulfil this wish with a DH 020 PFK. This brake calliper is pneumatically operated and spring-released, is suitable for 12.5 mm thick brake discs and is mounted at right angles to the brake disc. "Like many of our solutions, the highly standardised system can be configured and ordered directly in our webshop," emphasizes Franz Eisele. Elsewhere, it was a plastics technology plant manufacturer who, thanks to the DH 035 FPM brake type, was able to use

smaller, more cost-effective and low-maintenance motors for its drives. This spring-actuated and pneumatically released brake calliper can be equipped with different thrusters and adapted to brake discs of different thicknesses. It is attached at right angles to the brake disc. The precision with which RINGSPANN is able to adapt its brakes even to applications with high accuracy requirements can be seen in the example of a automated machine for deburring flat glass elements. In this case, it is a DH 005 PFK that holds the sensitive workpiece precisely in position during wet machining by a diamond grinding wheel. "This compact brake is a customized solution. It significantly increases the effectiveness of deburring," says Franz Eisele.

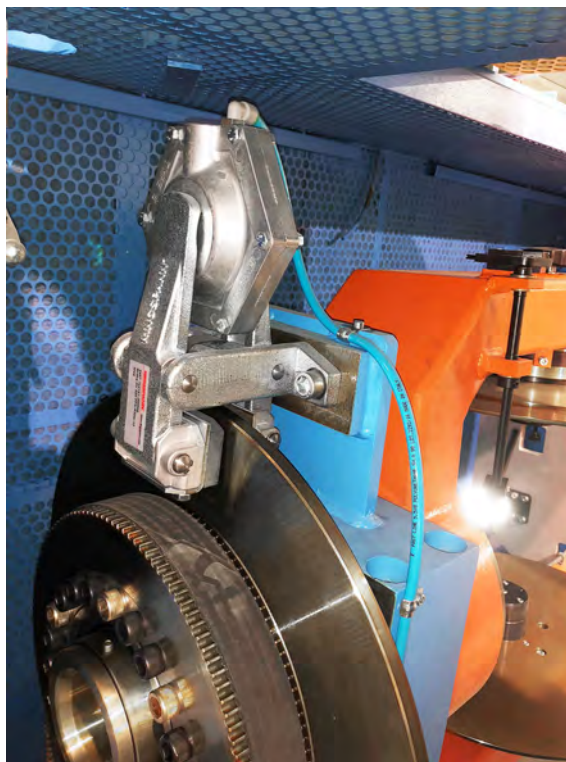

## Braking system as a smart solution

On the other hand brake systems of the DU class from RINGSPANN are used in special machines for the production of spherical and rolling elements. For the implementation of emergency stop solutions for operator protection, the designers choose the DU 060 FPM variant, for example, which is then equipped with oil-resistant friction linings. This spring-actuated and pneumatically released brake calliper already offers by default a high degree of flexibility: it can be mounted parallel or at right angles to the brake disc and can be provided at short notice with eight different thrusters mounted on the right or left side.

A concrete example of the implementation of a smart solution is the use of a DU 060 PFM in a centrifugal casting plant for pipe production. "Here we delivered the brake system as a complete solution, including a brake disc and cone clamping set for the shaft-hub connection. The customer thus receives everything they need for installation from a single source," says Franz Eisele. In this case, the braking system replaces a combination of frequency motor and stopper, which is complex in terms of control technology and was assessed as being too sluggish for emergencies and failures.

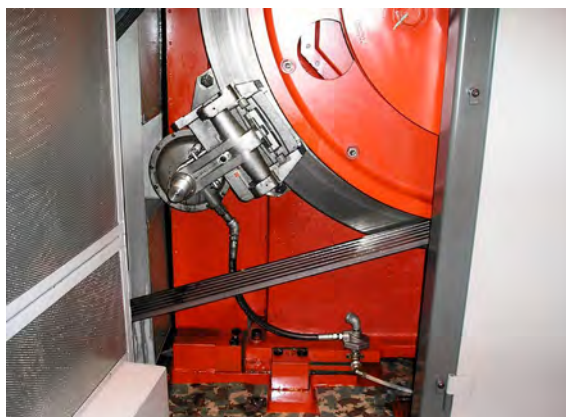

It covers three tasks at once: the fast, controlled slowing down of the drive, the safe "freezing" of the rotation when setting up the system, and the emergency stop function. The bottom line is that the machine manufacturer was able to achieve shorter cycles, simplify set-up operations, reduce the stopping times in case of emergency stops and reduce the number of its suppliers.

## Complete with clamping sets and couplings

"We also go deep into all areas of mechanical engineering with the brakes in our DV series," says Franz Eisele. As an example, he cites the use of ten brake callipers of the DV 030 FPM variant in the radial carriage of an aerospace riveting machine.

The disc brakes are part of the positioning and safety system: on the one hand, they fix the mobile radial carriage when riveting, and on the other hand, they stop the drive in the event of a gearbox damage. RINGSPANN also supplies these spring-operated and pneumatically released disc brakes for the positioning systems of robot-assisted welding cells, as components for tension control in wire drawing plants, or as a holding system in weaving machines. "We are currently increasingly providing plant manufacturers – for example in stranding, winding or plastics technology – with tailor-made DV brakes with matching brake discs, couplings, shaft-hub clamping sets, push and pull cables and hand levers as ready-to-install smart solutions," reports Franz Eisele.

Owing to their reliability and versatility, RINGSPANN brakes of the DH, DU and DV series are in great demand in many areas and niches of mechanical and plant engineering. However, the company offers numerous other types of brakes in

its one-stop shop that are of interest to designers of drive systems for production machines, conveyor systems or assembly systems. Worth mentioning at this point are, for example, the hydraulically released disc brakes of the HW- and HS-series – also suitable for heavy-duty applications – or electromagnetic EV- and EH-brakes, which are characterized by their particularly compact design. <<



## Favourite status in mechanical engineering

**The complete freewheels of the BM series from RINGSPANN are among the favourites of designers in the international mechanical and plant engineering sector, in particular because of their versatility and their flexibility in terms of assembly technology. Designed as standard for nominal torques of up to 57,500 Nm, they are primarily used here as backstops in transmissions and as overrunning freewheels in multimotor drive systems. Read here about the practical added value they offer machine builders and their customers.**

Many designers of high-quality drive systems for use in production machines and manufacturing plants opt for solutions from RINGSPANN's one-stop shop when selecting the necessary freewheels. The manufacturer's complete freewheels in the BM series are currently enjoying particularly brisk demand from this segment of the capital goods industry. These are sealed freewheels on ball-bearings that are supplied oil-filled and ready for installation. They are available as standard in 19 sizes with bore diameters of up to 150 mm and for nominal torques from 150 to 57,500 Nm. Manuel Assmann, designer in RINGSPANN's freewheel division, also points out at this point that "the maximum transmittable torque of these freewheels is twice as high as the specified nominal torque, and that the versions with bores from 15 to 90 mm can be made available to customers at very short notice." With this alone, the company already covers a wide range of applications that are typical for mechanical and plant engineering. On closer inspection, it becomes apparent that the complete freewheels of the BM series are

mainly used as backstops in transmissions and as overtaking freewheels in the powertrains of multimotor units. This means that the designers use them both for the implementation of safety and emergency stop devices (return/direction of rotation lock) and for the configuration of coupling solutions (overtaking/driving function).

### Keyway-groove connection offers advantages

The particular attractiveness of RINGSPANN's BM complete freewheels for drive technology applications in mechanical and plant engineering is based in addition on a number of crucial details of their design. Worth mentioning here is the keyway-groove connection on the outer ring of the freewheel. It offers three very specific advantages: versatile and uncomplicated integration of the freewheels into new and existing designs, installation effort reduced to a minimum and a high level of functional reliability. Manuel Assmann



explains: "Our keyway groove connection simplifies the installation and removal of the freewheel. In addition, power is transmitted via a keyway groove milled into the middle of the outer ring. This ensures an even distribution of the forces acting on the freewheel, which gives it a high level of operational reliability and service life." However, if the customer prefers to use a radially sliding retaining bolt instead of the keyway solution, it can be pulled out during maintenance work so that the drive system can then be rotated backwards.

## Clamping piece lift X as an alternative

Typical for RINGSPANN is that the ready-to-use complete freewheels of the BM series are also available in two basic versions with different clamping elements: in the standard design, they have clamping rollers – and are then also suitable as feed freewheels; in the second design, on the other hand, clamping pieces of type X specially developed by RINGSPANN work in their inside. Since these clamping pieces lift off the outer ring track of the freewheel due to their special geometry, as a result of centrifugal force in idle mode, BM complete freewheels fitted with them work largely wear-free and achieve a very long service life. "This applies to their use in backstop and overtaking functions and comes into play under the condition that the inner ring of the freewheel must follow a high shaft speed in idle mode,

## Speaking of housing freewheels

As the world market leader in freewheel technology, RINGSPANN also offers a wide range of housing freewheels. In order to simplify the selection and design process for designers, product developers and technical buyers at this point in its one-stop shop, the company recently launched a new online configurator. It guides users through all relevant data and selection options and is characterised by a calculation of the required torque, which takes into account the power data input and automatically determines the torque with the inclusion of a safety factor. After the calculation, the specified values are included in the product selection and result in a proposal for the appropriate housing freewheel. An inquiry can then be sent to RINGSPANN from the tool. Direct access to the configurator can be found via this link: [Configurator for housing freewheels.](#)

but the driving operation in the overtaking function runs slowly – which is quite typical for many applications in mechanical engineering," explains Manuel Assmann.

Typical applications of BM complete freewheels in mechanical and plant engineering include their use as backstops in helical gears or worm and screw presses, as components of the drive systems of sprockets, as overtaking freewheels for speed-dependent engagement and disengagement of the drive shafts of motors connected in series, and much more. In addition to the high quality and high availability of its service life-optimised, ready-to-install complete freewheels, RINGSPANN always offers its customers the option of configuring application-specific variants or implementing manufacturer-specific special solutions. <<

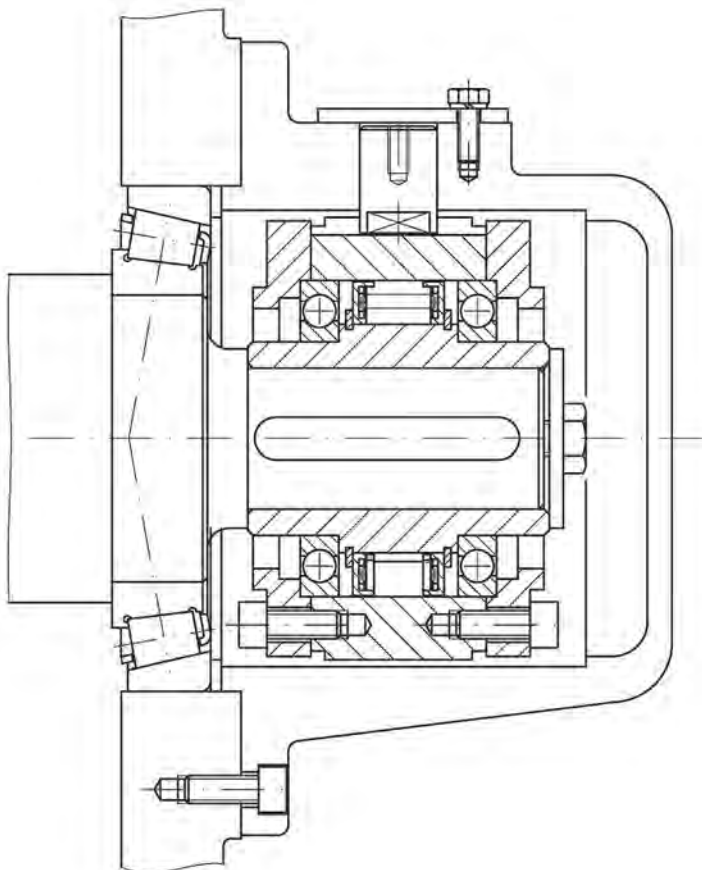

**Manuel Aßmann**  
Engineering Freewheels  
at RINGSPANN GmbH



Well thought-out down  
to the last detail





**The industrial brakes in the DX series are among the flagships in RINGSPANN's brake range. They were developed for use in the hoisting and travel drives of conveyor belts, cranes and bucket wheel systems and are designed for a high number of switching cycles on high-speed brake discs. After extensive re-engineering, the German company is now presenting the electro-hydraulic disc brakes as a trendsetter in the field of electro-hydraulic holding and emergency stop systems: implemented as a slim steel construction with a new angle lever and energy-efficient thrusters, they offer considerable added value to OEM designers as well as to operators and maintenance staff of the systems.**

"The primary goal in the re-engineering of the electro-hydraulic disc brakes of our DX series was to create an economical and convincing solution in every respect for the realisation of assembly-friendly, user-friendly and service-friendly holding and emergency stop systems for cranes, conveyor belt and bucket wheel systems," says Martin Ohler, Business Developer Brakes at RINGSPANN. In order to meet this requirement, he and his team carried out a number of benchmarks, market analyses and customer surveys, which ultimately resulted in significant specifications for a fundamental revision of the previous design. In addition, they set the course for groundbreaking optimisations, which already earned a great deal of praise from experts during the first presentations of the new DX brakes. Above all, there are three factors in particular that could make the new flagships in RINGSPANN's brake portfolio trendsetters in the industry. Firstly, designing important components – such as the

brake lever – using flame-cut steel (instead of cast iron). This not only gives the brakes a low unit price, but also simplifies their maintenance, servicing and general overhaul. In addition, the steel composition leads to a slim design of the brake. Secondly, the redesign of the angle lever, which forms the functional connection between the thruster, the brake spring and the brake levers, and has to absorb both bending and torsional forces. To prevent these forces from passing through to the brake levers and bushings, the angle lever has been designed to have the same high torsional rigidity as cast iron counterparts. It consists of only a few parts and is easy to assemble and replace. Thirdly, the flexibility of equipping them with various, partly new and energy-efficient thrusters from RINGSPANN's own production. Their indented installation also contributes to the compact design of the brake. "Overall, our new DX brakes have surprisingly small envelopes. This means that they are space-saving and

fit well into existing environments. In addition, they can be exchanged for other models without modifications," explains Martin Ohler.

Basically, the electro-hydraulic disc brakes of the DX series from RINGSPANN belong to the family of spring-operated fail-safe brakes. So they close on a power interruption and open via the thruster. Designed for a high number of switching cycles on high-speed discs with diameters of 500 to 1,000 mm, they apply clamping forces of up to 80 kN – depending on the variant. "As part of the re-engineering, we have also equipped the DX brakes with numerous detailed solutions that make it easier for OEM designers to integrate the brake into their drive system and offer many advantages to both plant operators and MRO personnel," says Martin Ohler.

## Wear compensation and self-centering

A closer look at some of the functional features of the DX 280 FEA, the top model in the series, shows what this means in concrete terms. The wear compensation of the brake pads, for example, can not only be readjusted manually, but also automatically via a maintenance-free freewheel device. The compensation ensures that the brake can always develop the same, high clamping force by compensating for the operationally increasing distance between the brake pad and the brake disc. The standard and maintenance-free self-centering, on the other hand, ensures that both brake levers can



be opened synchronously. As a result, the air gap on both sides of the brake disc remains equal – even if the brake pads continue to wear. A further compensation mechanism ensures that the brake pads are exactly parallel when ventilated. The distance between the pads and the brake disc is therefore decoupled from the V-position of the brake levers and is the same everywhere. This mechanism can be easily adjusted with adjusting screws.

## Thrusters from our own production

The DX 280 FEA can be equipped with various, partly new thrusters from RINGSPANN. They are suitable for braking torques from 1,700 to 28,100 N and clamping forces from 22.5 to 80 kN. Their task is to release the brake via an electrohydraulically generated counterforce to the brake spring. To build up this power, an electric motor, an impeller or gear pump and a piston cylinder interact in each of their compact housings. "Which thruster with which type of pump is preferred depends on the specific requirements for the brake. Important parameters here include opening and closing times, energy efficiency, maintenance costs and price," says Martin Ohler. The TH UEK 475 thruster, for example, has a gear pump that can generate high pressures with a low oil volume. When the brake is open, it switches to pressureless circulation, which reduces power consumption and wear. It enables extremely fast closing times of less than 80 ms and works completely analogue – i.e. without a control card! Since its solenoid valve coils are mounted externally, they are easy to replace.



## Large selection of sensors

The sensor range that RINGSPANN offers for the models of the revised DX series is extremely versatile. As standard, the brakes are equipped with easily accessible inductive sensors for monitoring brake release, brake closing, pad wear and manual release. Sensors of other types, and sensors with ATEX certificate and SIL approval, as well as load pins for measuring contact force and analogue sensors for supervising the reserve stroke as well as pad wear and temperature of the brake pad can be added as an option. This selection offers a great deal of scope for integrating DX brakes into Industry 4.0 environments, as well as for implementing comprehensive monitoring systems for preventive maintenance.

## Special models and a little sister

Thanks to their compact design and the mounting dimensions of the base plate, the new electro-hydraulic disc brakes of the DX series from RINGSPANN can easily replace worn-out disc brakes as part of modernisation projects. In addition, the brake is available in special versions for marine, very cold and very warm environments as well as an explosion-proof model. And a little sister can also be found in the RINGSPANN one-stop shop: it has a maximum clamping force of 25 kN and is called DX 230 FEA. <<

## Highlighting the added value

RINGSPANN has highlighted the functionality and design advantages of its DX 280 FEA electro-hydraulic disc brake in a video. In just under five minutes, Martin Ohler, Business Developer Brakes, and his colleague Manuel Franz, Product Manager Brakes, explain the added value that this spring-actuated and electrohydraulically released disc brake offers OEM designers, system operators and maintenance staff.

**Martin Ohler**  
RINGSPANN-Business  
Developer Brakes





# Strategic expansion in the heavy-duty sector

**RINGSPANN has taken over the German company Kempf Universal Cardan Shafts with effect from 1 September 2024. The Gersfeld-based manufacturer is regarded as a technology specialist in the field of drive shafts. The RINGSPANN Group is thus growing by another production site and is strengthening its international competitive position in the markets of the steel and paper industry as well as gas extraction.**

In the field of freewheel technology, RINGSPANN has been the world market leader for decades. The company is also continuing to expand the range of its one-stop shop with great commitment in other product divisions of industrial drive technology. After acquiring the US coupling manufacturer AISCO in 2023, and also integrating numerous new series of industrial brakes into its portfolio, it is now announcing the next decision in its long-term growth strategy: With effect from September 1, 2024, RINGSPANN has taken over the medium-sized company Kempf Universal Cardan Shafts GmbH.

The Bad Homburg-based company is thus implementing three important projects at once: first, it is a big step closer to its goal of doubling its coupling sales by 2029. Second-

ly, with the integration of Kempf's product range, it is expanding its range to include numerous established series of heavy-duty drive shafts. In particular, it is thus strengthening its international market position as a supplier to plant manufacturers in the steel and paper industries as well as in gas extraction. And thirdly, with the production plant in Gersfeld, the RINGSPANN Group will have an additional production site in Germany and thus continue to focus on quality Made in Germany. "We can well imagine setting up a European competence and technology centre here in the future for the development, manufacture and supply of articulated, gear and steel belt couplings for use in the drive systems of heavy-duty applications," says RINGSPANN Managing Director Fabian Maurer.

## Technology boost in the drive shaft sector

The acquisition of the medium-sized company Kempf Universal Cardan Shafts is a further logical step in the RINGSPANN Group's expansion and growth strategy to date. It is thus securing the know-how gained from more than 60 years of experience in the development and production of drive shafts of the highest quality and with torques of up to 284,000 Nm. These drive shafts are primarily used in paper machines, rolling mills in the steel industry, plants for renewable energy technology, plants in the oil and gas industry, in special machine and vehicle construction as well as in the drives of rail and water vehicles.



## New member in a strong group

This is a friendly takeover. Under its General Manager Jochen Helfrich, Kempf Universal Cardan Shafts – which emerged from Gebrüder Kempf GmbH, founded in 1963 – has been on a continuous growth course for a good four years. The company has a solid customer base and has a high level of vertical integration, especially in CNC metalworking and gearing technology. "However, we would soon reach our limits in sales, so that we will now benefit considerably from the internationality of the RINGSPANN Group and the integration into its modern sales structures. In addition, RINGSPANN's know-how in the areas of process optimisation, information technology and marketing will decisively drive us going forward," says Jochen Helfrich.

The new member of the group will operate as RINGSPANN Kempf GmbH. The management of the company remains in the proven hands of General Manager Jochen Helfrich and his authorised signatories, Chief Designer Matthias Trabert

and Purchasing Manager Alexander Walter. The 34-strong workforce will also be taken over in its entirety. "In this way, we retain the diverse skills, know-how and experience of our employees. This should also significantly accelerate all upcoming processes as part of the organisational and technical integration into the RINGSPANN Group," says Managing Director Fabian Maurer.

## Attractive prospects

With the acquisition of Kempf Universal Cardan Shafts, RINGSPANN is also acquiring a site with over 24,000 square metres, which is currently only partly used for production and warehousing. This offers the company a lot of potential for further expanding the location into a hub for drive shaft technology in Europe. Apart from that, the significant expansion of the RINGSPANN one-stop shop with the products of the Kempf range opens up numerous new perspectives for the compilation of customised system offers. These machine elements can often be combined with other components of the RINGSPANN portfolio to form delivery packages that can then be provided completely from a single source. <<



*With the integration of Kempf Universal Cardan Shafts the RINGSPANN Group is strengthening its international market position as a supplier for plant manufacturers in energy technology, raw material extraction and the steel and paper industry. In the picture: Fabian Maurer (l), Managing Director of RINGSPANN, and Jochen Helfrich (r), Managing Director of RINGSPANN Kempf.*

# Greater sustainability in the powertrain

Worldwide, RINGSPANN freewheels are used in the propulsion systems of ships, harbour cranes and hydro, offshore and mining engineering, among other things. Specially tailored to the strict environmental regulations in these seawater and groundwater-related application areas, the company now supplies all freewheel series with biodegradable lubricants at the customer's request. This offers designers even more leeway for the realisation of sustainable drives, gears and hoists.

Minimising the ecological footprint of technical systems and improving the life cycle assessments of complex drive systems has long been one of the requirements that designers and development engineers must keep in mind when realising competitive drives, gears and hoists. The use of environmentally friendly and sustainable drive units is becoming increasingly important, especially in shipbuilding, in the manufacture of harbour cranes and in offshore, hydro and mining technology. RINGSPANN has therefore carried out an extensive series of tests in recent months, focusing on the use of biocompatible lubricants for freewheels. The result is now clear: From now on, the company is in a position to provide its customers with any freewheel type from its one-stop shop in addition to the standard version as a variant with a biodegradable lubricant. "In this way, we are significantly expanding the scope of action of the designers of drive trains in contact with seawater and groundwater – regardless of whether they use our freewheels for indexing or overrunning functions or as backstops," says Manuel Assmann, freewheel specialist at RINGSPANN.



**Manuel Assmann**  
Engineering Freewheels  
at RINGSPANN GmbH

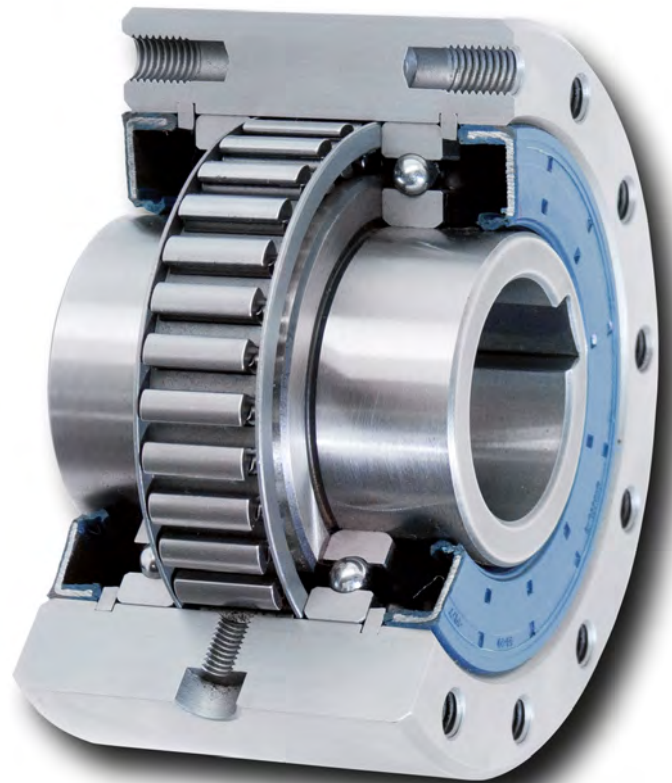

## Same price for the same performance

It is noteworthy that RINGSPANN freewheels with environmentally friendly lubricants are absolutely identical in construction to conventionally lubricated versions, that they have the same performance capacity and that they do not differ in price from the standard types. "Since all parameters remain identical except for the use of biocompatible lubricants, a problem-free 1:1 replacement of the freewheels can also be carried out during re-engineering, retrofitting or maintenance - without compromising on performance and with full cost transparency," emphasises Manuel Assmann.

To achieve this result, the freewheel experts at RINGSPANN tested various bio-lubricants in a specially built test stand and compared their performance data with that of conventional oils and greases. For example, several sealed complete sprag freewheels with ball bearings in the FB/FBE series, which is in use worldwide, were filled differently and subjected to a long-term test. Important: in the freewheel direction, the inner ring of these freewheels can be twisted towards the outer ring. In the opposite direction, however, the inner and outer rings form a force-fit connection



## Ready-to-install and sustainable

RINGSPANN is the world market leader in the field of freewheel technology. The complete freewheels of the FB and FBE series mentioned in the text are ready-to-install sprag freewheels. They are available for nominal torques of up to 160,000 Nm and are suitable for indexing and overrun functions as well as for use as backstops. They are ball bearing mounted, sealed, filled with lubricant and supplied ready for assembly, and are used, for example, in the implementation of hybrid boat drives. Filled with biodegradable lubricants, they are an ideal solution for the realisation of drive trains near seawater and groundwater in shipbuilding and crane construction, as well as in offshore, hydro and mining technology.



through the sprags. This creates high radial forces between the raceways and sprags – and the lubricants. Loaded with a nominal torque of 200 Nm, the complete freewheels had to cope with a switching frequency of 4.5 strokes per second in the RINGSPANN test stand at all times. "In this typical scenario, the wheat was quickly separated from the chaff, and we were able to clearly see which biocompatible lubricants meet our quality standards," reports Manuel Assmann.

## "Contemporary alternative"

With the option of now being able to provide all freewheels in its extensive portfolio with biodegradable lubricants, RINGSPANN is making a valuable contribution to the implementation of the sustainability concepts envisaged in many places in drive technology. As mentioned, in addition to designers in boat and yacht building, as well as crane construction, manufacturers of drive systems for hydropower, offshore and mining systems are likely to benefit from this. In addition, RINGSPANN freewheels with environmentally friendly lubricants are also likely to prove to be an ideal solution for the implementation of marine and submarine facilities – such as current power plants or lock systems. "Our biocompatible freewheel technology is a contemporary alternative in terms of sustainability wherever drive trains can come into contact with seawater or groundwater and the legislator prohibits or restricts the use of conventional lubricants," says Manuel Assmann. <<

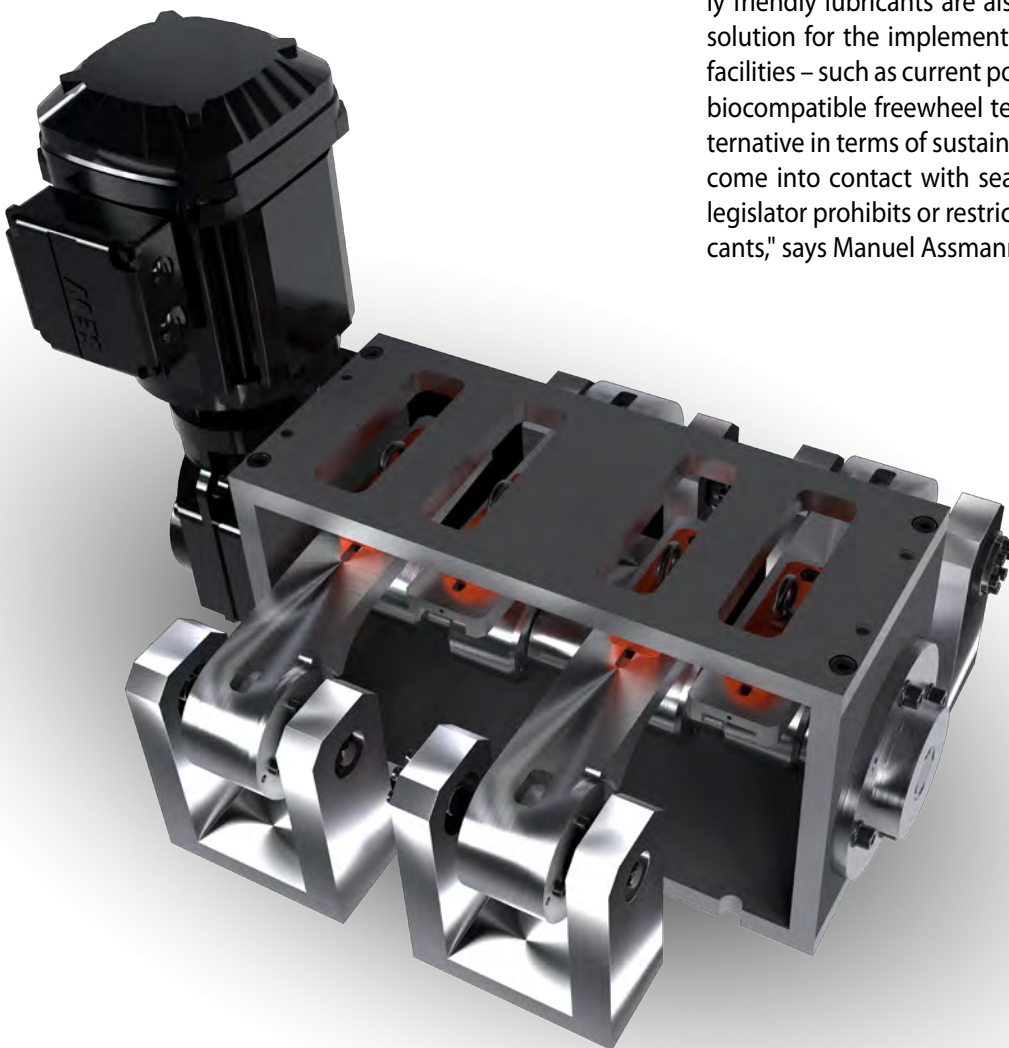

## „Further milestone in the internationalisation achieved“

**A few days ago, RINGSPANN founded its new subsidiary in Turkey. The globally active company headquartered in Bad Homburg vor der Höhe is thus implementing a further milestone in its long-term internationalisation strategy. RINGSPANN Turkey Ltd. is based in Istanbul and will also be available as a contact and service partner for power transmission components and push-pull cable systems for customers in the Turkic states.**

The RINGSPANN Group is consistently continuing its internationalisation course. On 1 October 2024, the German company's 17th foreign subsidiary commenced business operations on the Bosphorus. From Istanbul, RINGSPANN Turkey Güç Aktarım Sistemleri Ticaret Limited Şirketi (Power Transmission Systems Trade Ltd.) will now support customers in Turkey as well as in Kazakhstan, Azerbaijan, Turkmenistan and Uzbekistan in the selection of drive components and push-pull cables from RINGSPANN. Daniel Riedel, Head of Sales and Marketing at the company, emphasises on the strategic role of the new subsidiary: "From Istanbul, we are not only moving closer to our customers in Turkey with our products and services, but are also intensifying our presence in the emerging mining industries of the Middle Eastern economic region on the other side of the Caspian Sea. We are thus also responding to the growing interest of the Turkic states - especially Turkey - in all products from our one-stop shop."

### Entire portfolio on offer

With RINGSPANN Turkey Ltd.'s services, machine builders and gearbox manufacturers in Turkey and the Turkic states now have easier access to the company's freewheels, shaft-hub-connections, overload clutches, industrial brakes, precision clamping fixtures and remote control systems. Murat Sarı, the new General Manager of RINGSPANN Turkey Ltd, says: "The mining industries in the Turkic states in particular, are currently under great pressure to modernise. From Istanbul, we can now respond to this more quickly and flexibly than before - regardless of whether new or spare parts are required. We will also gradually increase our service quality in this region of the Middle East."

### Internationalisation as a continuous mission

The founding of RINGSPANN Turkey Ltd. is by no means the end of the Bad Homburg-based company's international expansion. For Daniel Riedel, this is "simply another milestone in our long-term internationalisation strategy. We are constantly on the lookout for further meaningful opportunities to further strengthen and expand our presence abroad." <<



**Murat Sarı**  
General Manager  
RINGSPANN Turkey



**Daniel Riedel**  
Head of Sales & Marketing,  
RINGSPANN GmbH



# Advertising motifs

**RINGSPANN®**  
Your benefit is our motivation



**FREEWHEELS**  
Backstops • Overrunning Clutches • Indexing Free wheels



[www.ringspann.com](http://www.ringspann.com)

**RINGSPANN®**  
Your benefit is our motivation



**INDUSTRIAL BRAKES**  
hydraulic • pneumatic • electrical



[www.ringspann.com](http://www.ringspann.com)

**RINGSPANN®**  
Your benefit is our motivation



**COUPLINGS**  
rigid • torsionally rigid • elastic



[www.ringspann.com](http://www.ringspann.com)

**RINGSPANN®**  
Your benefit is our motivation



**CLAMPING FIXTURES**  
Clamping Chucks • Clamping Mandrels • Clamping Clutches



[www.ringspann.com](http://www.ringspann.com)

# 2024

**RINGSPANN®**

**RINGSPANN®**  
Your benefit is our motivation



**INDUSTRIAL BRAKES**  
hydraulic • pneumatic • electrical



[www.ringspann.com](http://www.ringspann.com)

**RINGSPANN®**  
Your benefit is our motivation



**SHAFT-HUB-CONNECTIONS**  
Shrink Discs • Cone Clamping Elements • Clamping Systems



[www.ringspann.com](http://www.ringspann.com)

**RINGSPANN®**  
Power Transmission • Clamping Fixtures



**Publisher**

RINGSPANN GmbH  
Schaberweg 30-38  
61348 Bad Homburg  
Deutschland  
+49 6172 275-0  
info@ringspann.de  
www.ringspann.de

**Editorial staff**

Graf & Creative PR  
RINGSPANN GmbH

**Layout**

RINGSPANN GmbH

**Photo credit**

RINGSPANN GmbH  
©Amarinj @Adobe Stock  
© Andrea @Adobe Stock

